

Green Pin® Snatch Block HK
 Group : P-6952
 Part : BKOFFSH0404
 WLL : 4t

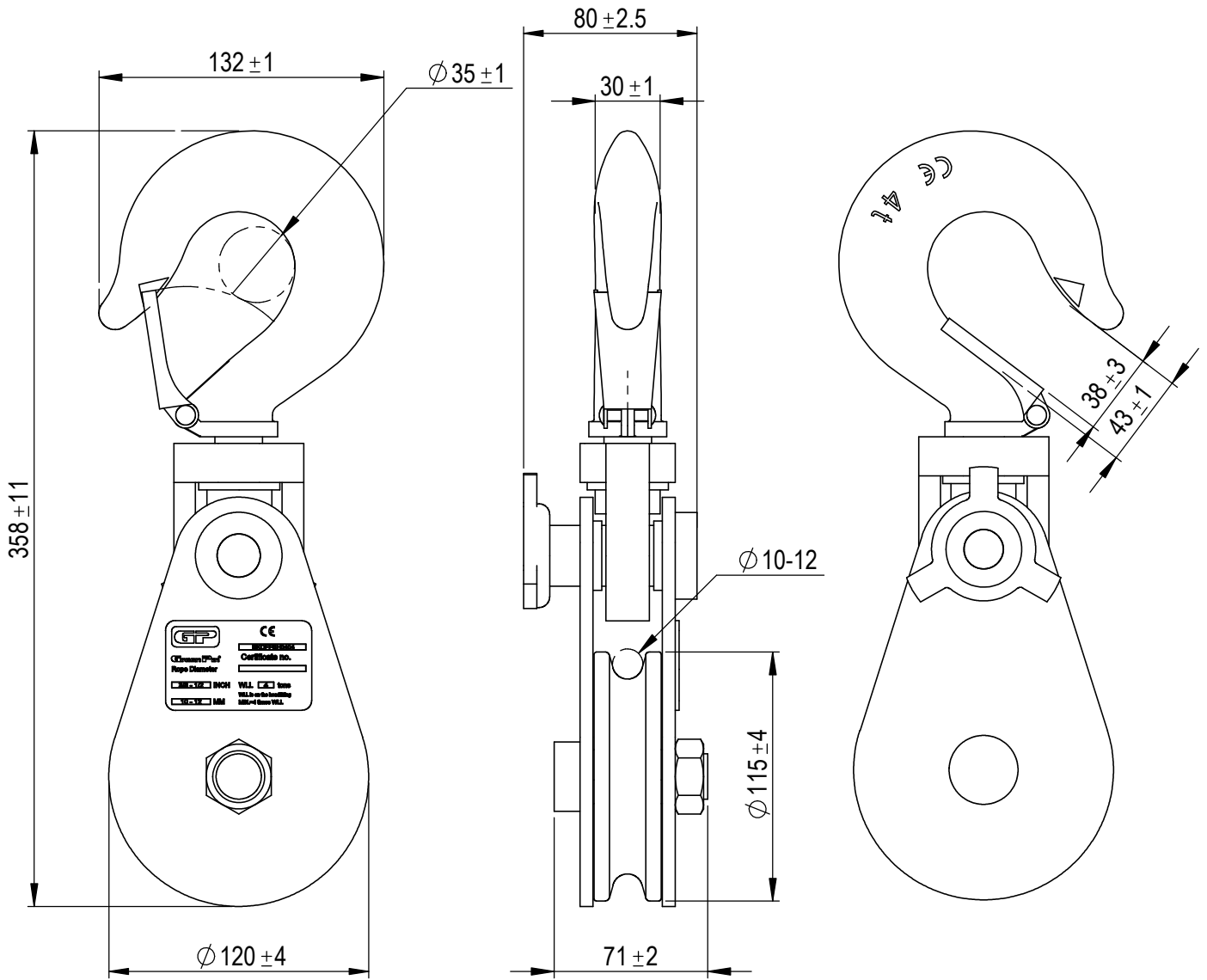

We reserve the right to make amendments on specifications in this drawing without prior notification.

0	First issue	2022-11-2	R.CH
Rev.	Description	Date	Drawn

Copyright by Van Beest B.V. moreover this document is the property of Van Beest B.V. This document or any part of it may neither be made known, copied or multiplied, nor used for any purpose other than that for which it is specifically furnished, without the prior written consent of Van Beest B.V.



P.O. Box 57, 3360 AB Sliedrecht (The Netherlands)
 Industrieweg 6, 3361 HJ Sliedrecht
 Tel. +31(0)184-413300 www.greenpin.com

Format	A4		
Scale	1:3		
Drawing number		9891	Rev.
			0

Title **Green Pin® Snatch Block HK**

Remark
 P-6952
 BKOFFSH0404