

Green Pin® Snatch Block HK
 Group : P-6952
 Part : BKOFFSH1215
 WLL : 15t

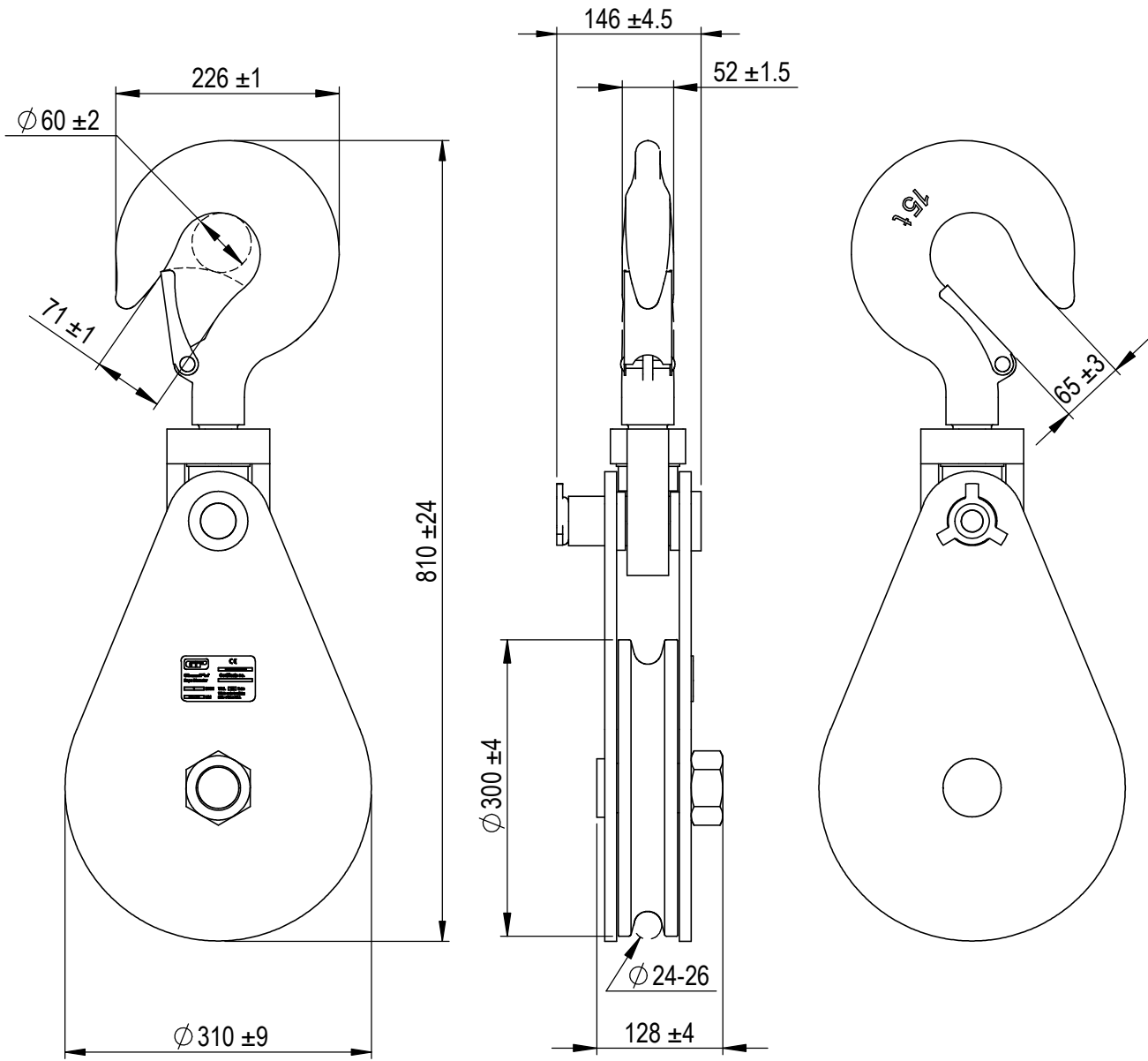

We reserve the right to make amendments on specifications in this drawing without prior notification.

Rev.	Description	Date	Drawn
0	First issue	2022-12-1	DL

Copyright by Van Beest B.V. moreover this document is the property of Van Beest B.V. This document or any part of it may neither be made known, copied or multiplied, nor used for any purpose other than that for which it is specifically furnished, without the prior written consent of Van Beest B.V.



P.O. Box 57, 3360 AB Sliedrecht (The Netherlands)
 Industrieweg 6, 3361 HJ Sliedrecht
 Tel. +31(0)184-413300 www.greenpin.com

Format	A4	
Scale	1:6.75	
Drawing number	9905	Rev.
		0

Title	Green Pin® Snatch Block HK	Remark	P-6952 BKOFFSH1215
-------	----------------------------	--------	-----------------------