

Green Pin® Lifting chain EN818-2 GR8  
 Group : CHAIN  
 Part : GPCHAIN10  
 WLL : 3.15t

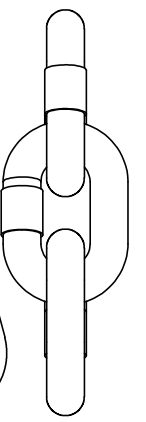
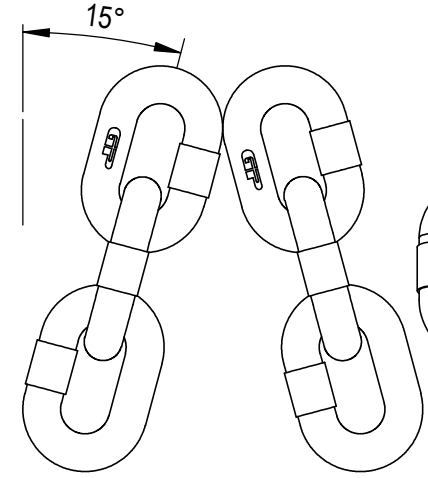
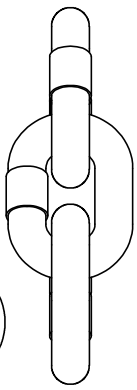
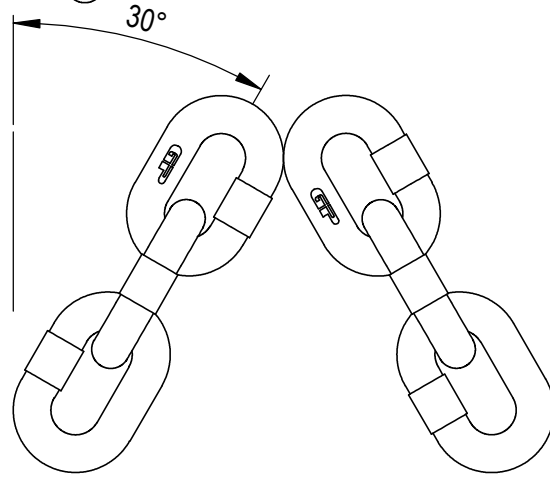
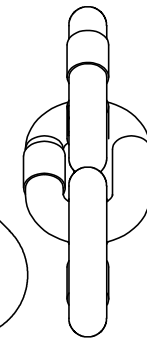
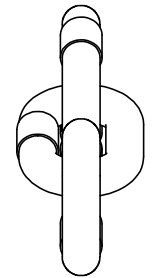
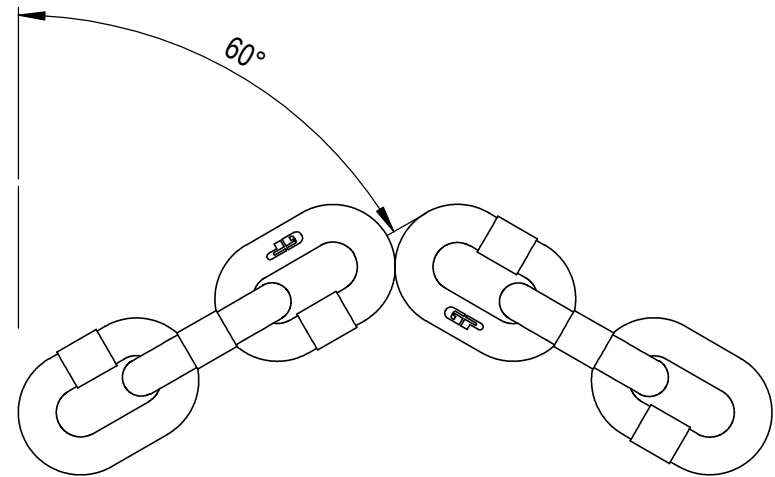
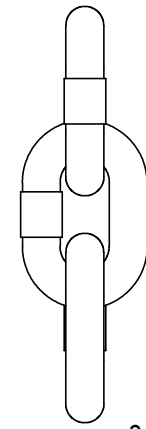
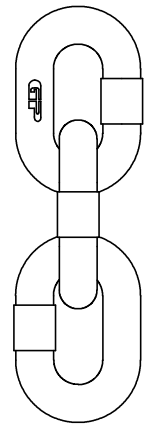
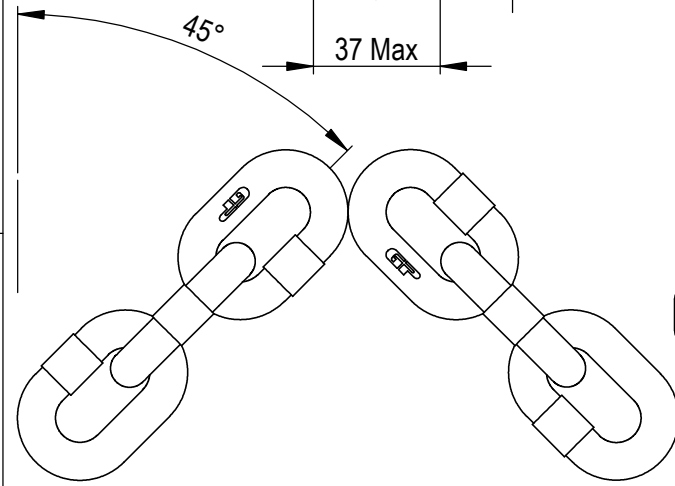
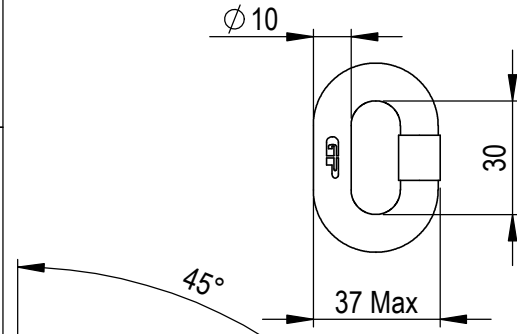

Rev.	Description	Date	Drawn
A	Add the GP logo marking	2019-8-7	R.CH
0	First Issue	2017-12-15	R.CH

Copyright by Van Beest B.V. moreover this document is the property of Van Beest B.V. This document or any part of it may neither be made known, copied or multiplied, nor used for any purpose other than that for which it is specifically furnished, without the prior written consent of Van Beest B.V.

Title **Green Pin® Lifting chain EN818-2 GR8**  
 Remark  
 CHAIN  
 GPCHAIN10



P.O. Box 57, 3360 AB Slidrecht (The Netherlands)  
 Industrieweg 6, 3361 HJ Slidrecht  
 Tel. +31(0)184-413300 www.greenpin.com

Format	A4	
Scale	1:2	
Drawing number	7907	Rev. A

We reserve the right to make amendments on specifications in this drawing without prior notification.