

Green Pin® Lifting chain EN818-2 GR8
 Group : CHAIN
 Part : GPCHAIN32
 WLL : 31.5t

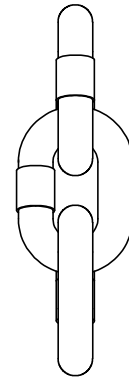
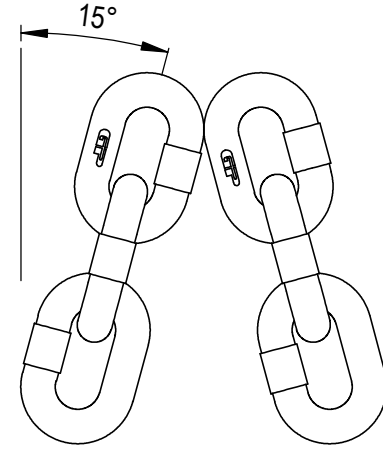
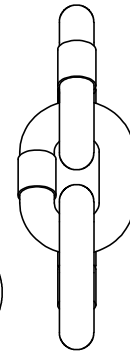
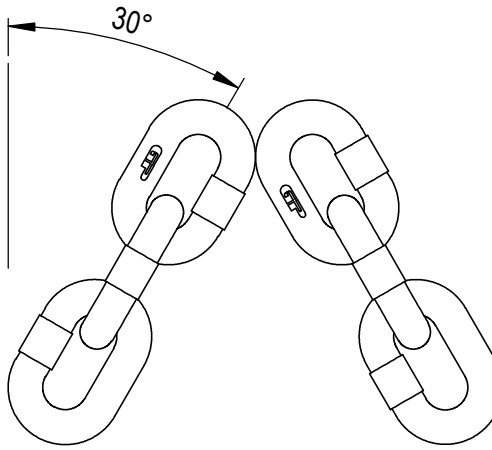
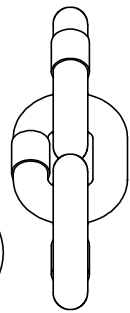
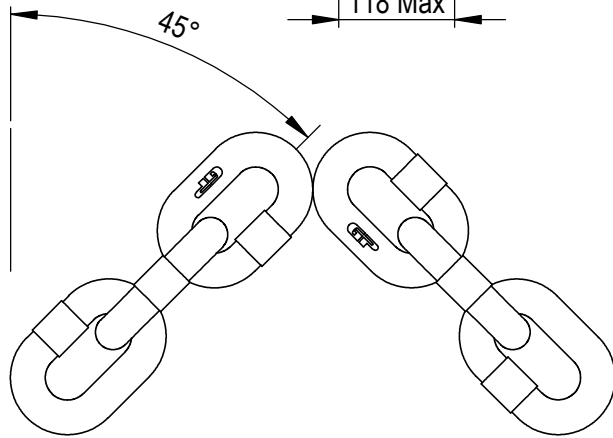
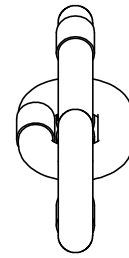
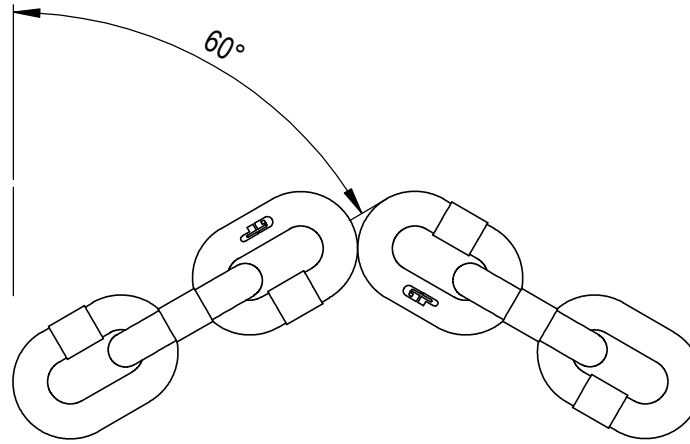
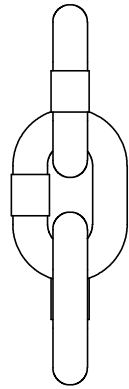
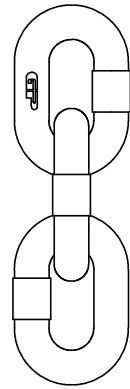
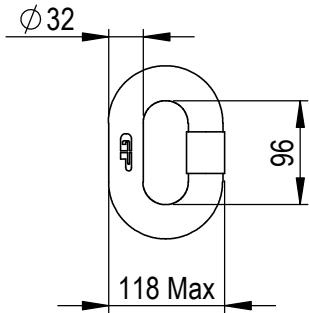

Rev.	Description	Date	Drawn
A	Add the GP logo marking	2019-8-7	R.CH
0	First Issue	2017-12-15	R.CH

Copyright by Van Beest B.V. moreover this document is the property of Van Beest B.V. This document or any part of it may neither be made known, copied or multiplied, nor used for any purpose other than that for which it is specifically furnished, without the prior written consent of Van Beest B.V.

Title Green Pin® Lifting chain EN818-2 GR8

Remark
 CHAIN
 GPCHAIN32



P.O. Box 57, 3360 AB Sliedrecht (The Netherlands)
 Industrieweg 6, 3361 HJ Sliedrecht
 Tel. +31(0)184-413300 www.greenpin.com

Format	A4	
Scale	1:7	

Drawing number	7919	Rev.	A
----------------	------	------	---

We reserve the right to make amendments on specifications in this drawing without prior notification.