

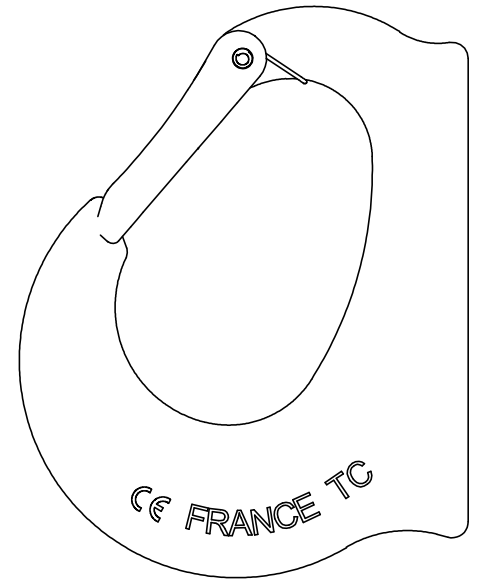

Green Pin® Excavator Hook GR8
 Group : GH
 Part : GPGH10
 WLL : 10t

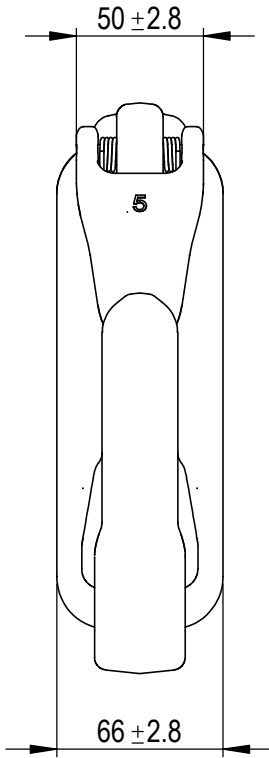

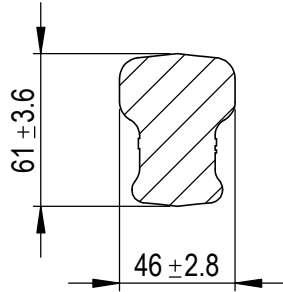
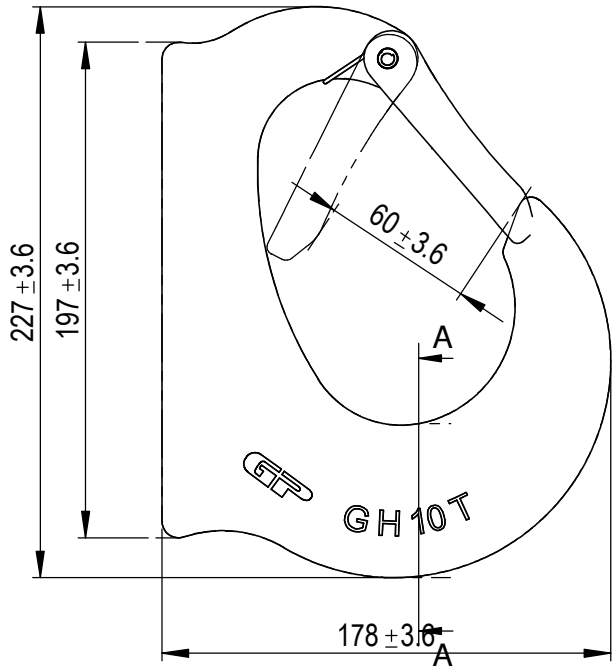

| | | | |
|--|-------------|------------------------|-------|
| 0 | First Issue | 2020-04-20 | R.CH |
| Rev. | Description | Date | Drawn |
| Copyright by Van Beest B.V. moreover this document is the property of Van Beest B.V. This document or any part of it may neither be made known, copied or multiplied, nor used for any purpose other than that for which it is specifically furnished, without the prior written consent of Van Beest B.V. | | | |
| Title Green Pin® Excavator Hook GR8 | | Remark GH GPGH10 | |



Green Pin®

P.O. Box 57, 3360 AB Sliedrecht (The Netherlands)
 Industrieweg 6, 3361 HJ Sliedrecht
 Tel. +31(0)184-413300 www.greenpin.com

| | | |
|----------------|-----|---|
| Format | A4 |   |
| Scale | 1:3 | |
| Drawing number | | Rev. |
| 6377 | | 0 |

We reserve the right to make amendments on specifications in this drawing without prior notification.