

Green Pin® Connecting Link S/S-GR5

Group : MJI

Part : GPMJ6I

WLL : 0.7t

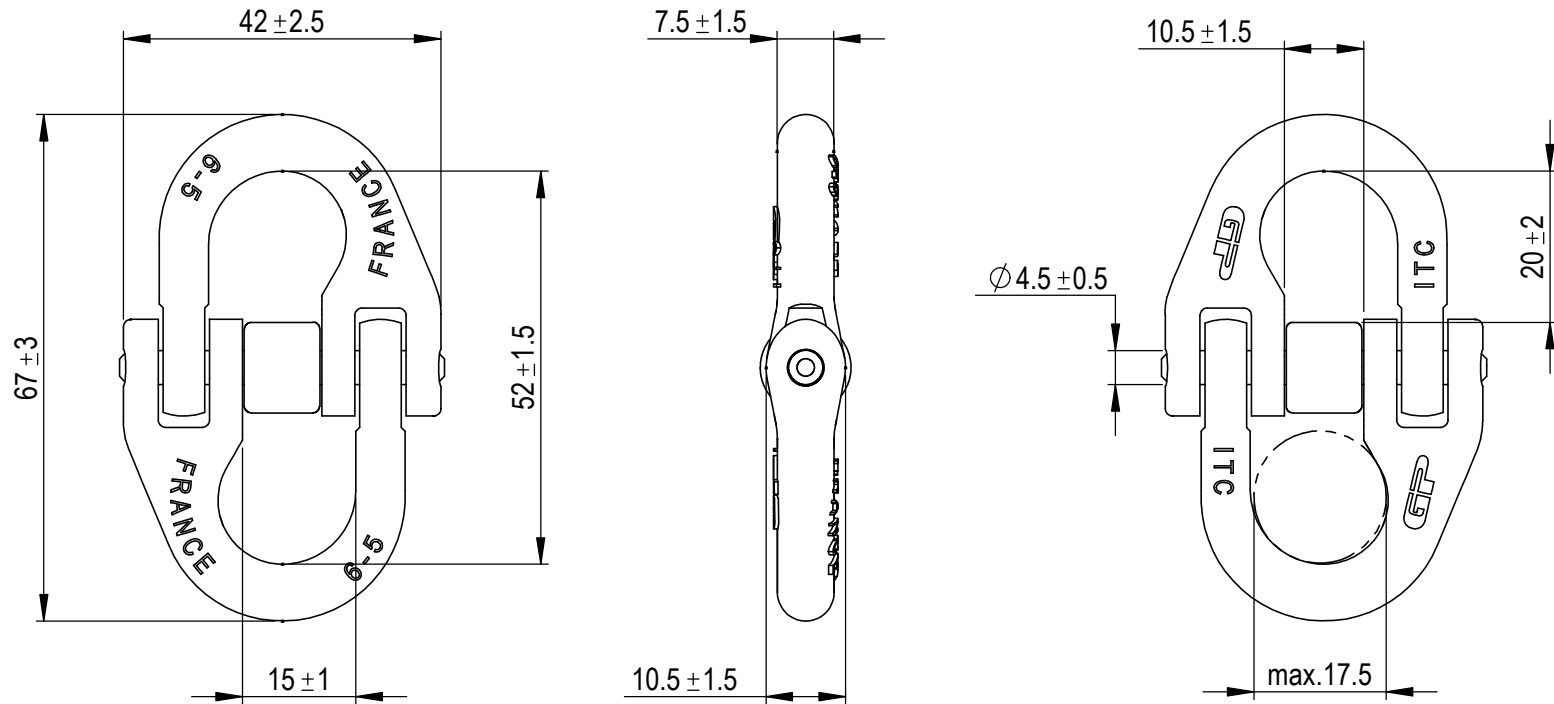

0	First Issue	2018-11-17	R.CH
Rev.	Description	Date	Drawn
Copyright by Van Beest B.V. moreover this document is the property of Van Beest B.V. This document or any part of it may neither be made known, copied or multiplied, nor used for any purpose other than that for which it is specifically furnished, without the prior written consent of Van Beest B.V.			
Title Green Pin® Connecting Link S/S-GR5		Remark MJI GPMJ6I	



P.O. Box 57, 3360 AB Sliedrecht (The Netherlands)
 Industrieweg 6, 3361 HJ Sliedrecht
 Tel. +31(0)184-413300 www.greenpin.com

Format	A4	
Scale	1:1	
Drawing number	5680	Rev. 0

We reserve the right to make amendments on specifications in this drawing without prior notification.