

Green Pin® Master Link EN1677-4 GR8
 Group : MS
 Part : GPMS45
 WLL : 37t

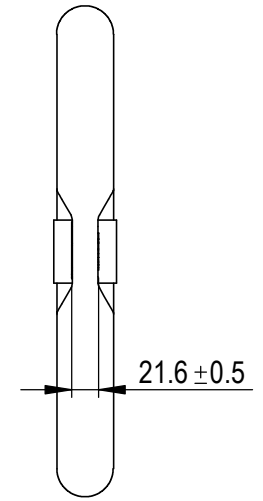
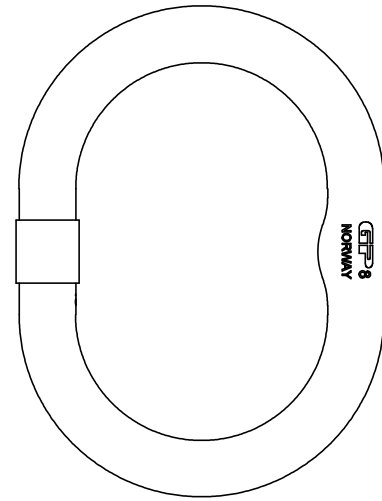
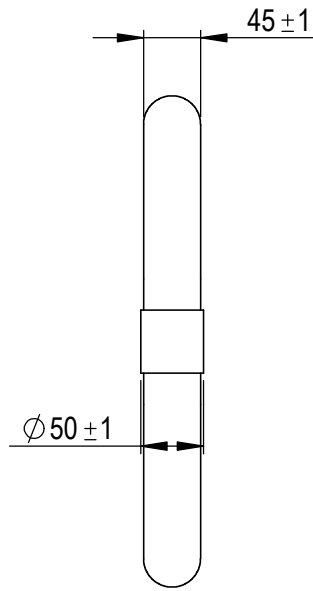
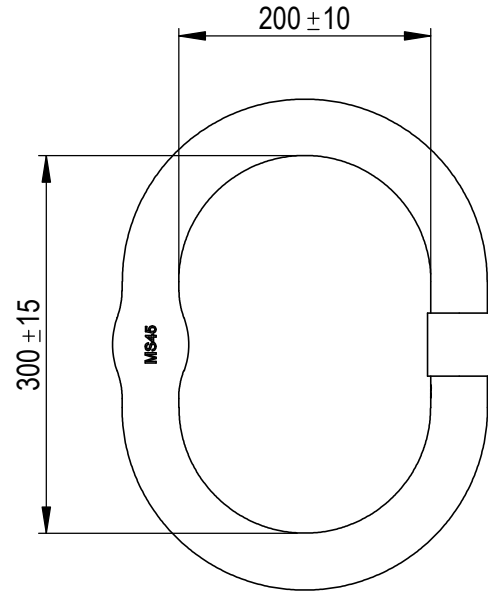

Rev.	Description	Date	Drawn
A	Modify the marking	2021-3-31	R.CH
0	First Issue	2015-3-1	R.CH

Copyright by Van Beest B.V. moreover this document is the property of Van Beest B.V. This document or any part of it may neither be made known, copied or multiplied, nor used for any purpose other than that for which it is specifically furnished, without the prior written consent of Van Beest B.V.

Title **Green Pin® Master Link EN1677-4 GR8**
 Remark
 MS
 GPMS45

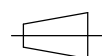

P.O. Box 57, 3360 AB Sliedrecht
 (The Netherlands)
 Industrieweg 6, 3361 HJ Sliedrecht
 Tel. +31(0)184-413300 www.vanbeest.nl

Format	A4	 
Scale	1:6	
Drawing number	5711	Rev. A

We reserve the right to make amendments on specifications in this drawing without prior notification.