

Green Pin® Master Link Assembly En1677-4 GR8

Group : MTS

Part : GPMTS50

WLL : 40t

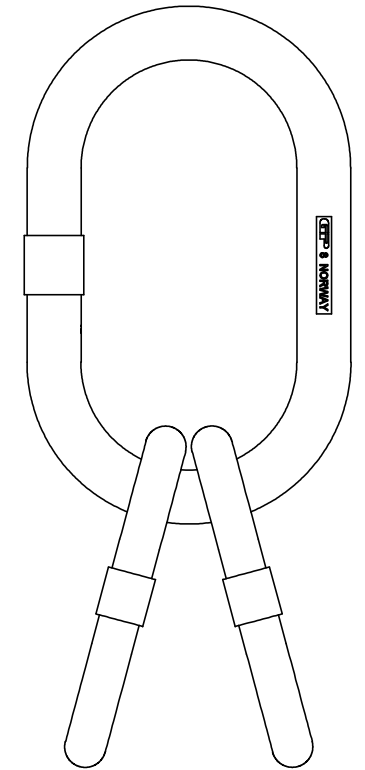
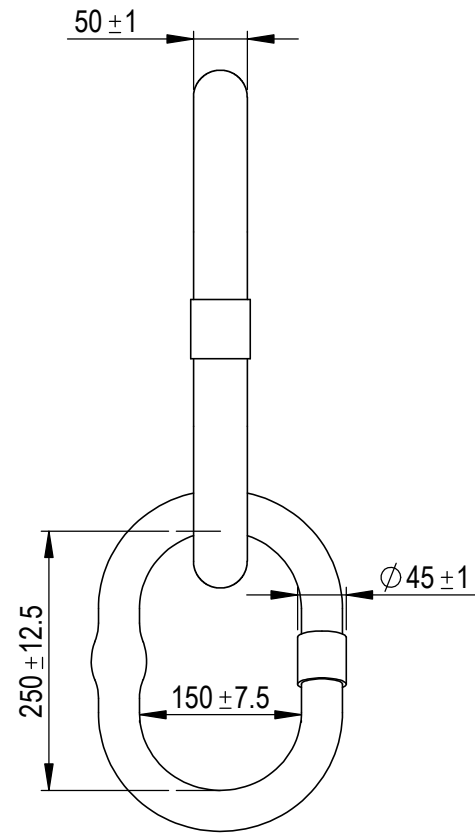
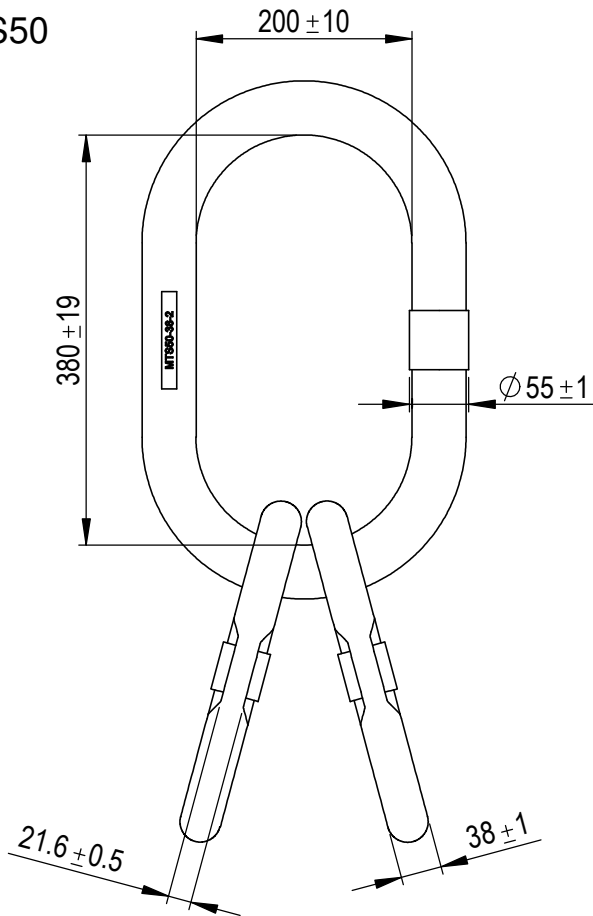

Rev.	Description	Date	Drawn
A	Modify the marking	2021-3-31	R.CH
0	First Issue	2015-3-1	R.CH

Copyright by Van Beest B.V. moreover this document is the property of Van Beest B.V. This document or any part of it may neither be made known, copied or multiplied, nor used for any purpose other than that for which it is specifically furnished, without the prior written consent of Van Beest B.V.

Title Green Pin® Master Link Assembly En1677-4 GR8

Remark
MTS
GPMTS50



P.O. Box 57, 3360 AB Sliedrecht
(The Netherlands)
Industrieweg 6, 3361 HJ Sliedrecht
Tel. +31 (0)184-413300 www.vanbeest.nl

Format	A4	
Scale	1:7	
Drawing number	5759	Rev. A

We reserve the right to make amendments on specifications in this drawing without prior notification.