

Green Pin® ROV Shank Hook E GR8
 Group : P-6740
 Part : GPSH0016ROV
 WLL : 16t

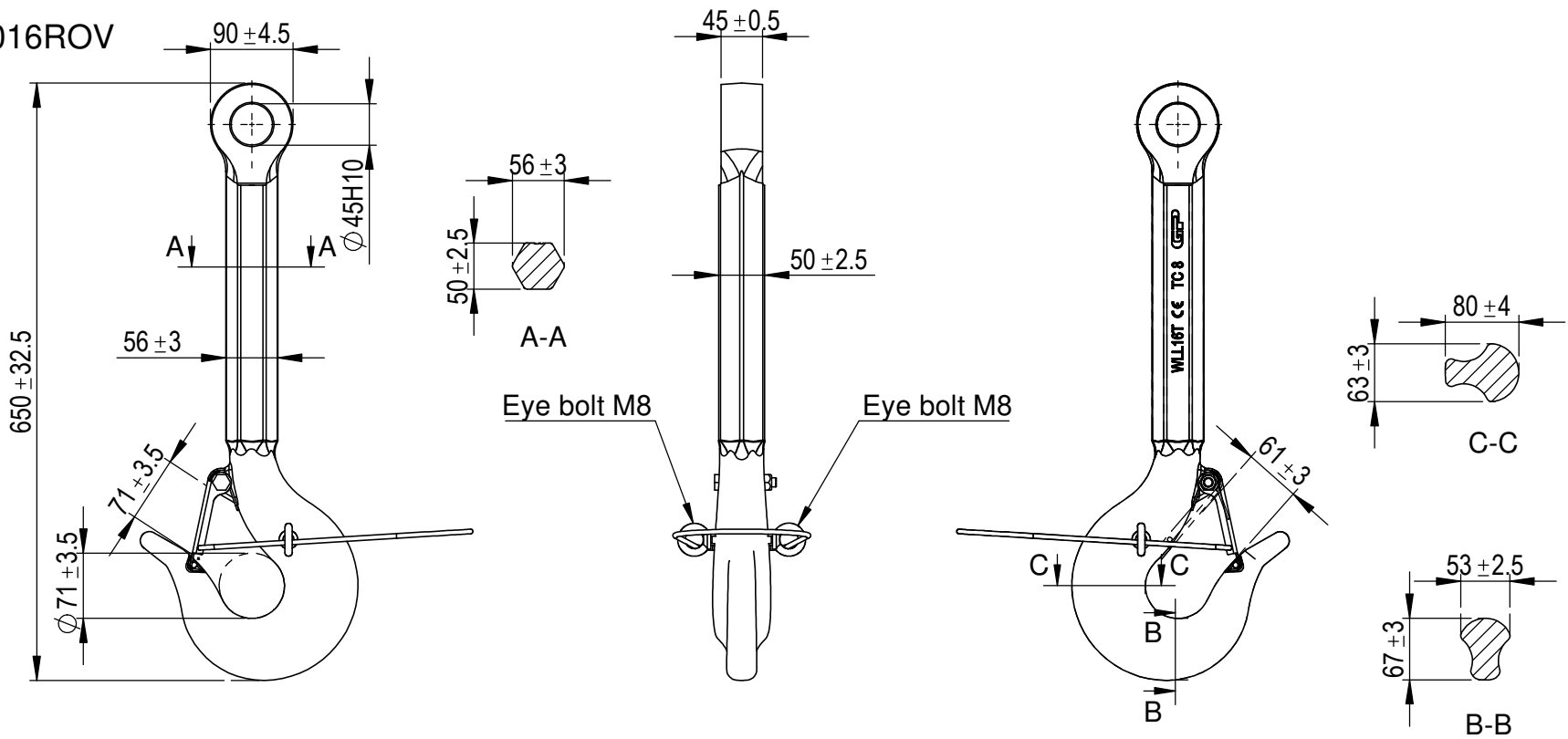

Rev.	Description	Date	Drawn
A	Design modification	2021-09-05	R.CH
0	First Issue	2021-08-15	R.CH

Copyright by Van Beest B.V. moreover this document is the property of Van Beest B.V. This document or any part of it may neither be made known, copied or multiplied, nor used for any purpose other than that for which it is specifically furnished, without the prior written consent of Van Beest B.V.

Title **Green Pin® ROV Shank Hook E GR8**

Remark
 P-6740
 GPSH0016ROV



Green Pin®
 P.O. Box 57, 3360 AB Sliedrecht (The Netherlands)
 Industrieweg 6, 3361 HJ Sliedrecht
 Tel. +31(0)184-413300 www.greenpin.com

Format	A4		
Scale	1:7.5		
Drawing number	5601	Rev.	A

We reserve the right to make amendments on specifications in this drawing without prior notification.