

Green Pin® Omega link GR10
 Group : UCO
 Part : GPUCO8
 WLL : 2.6t

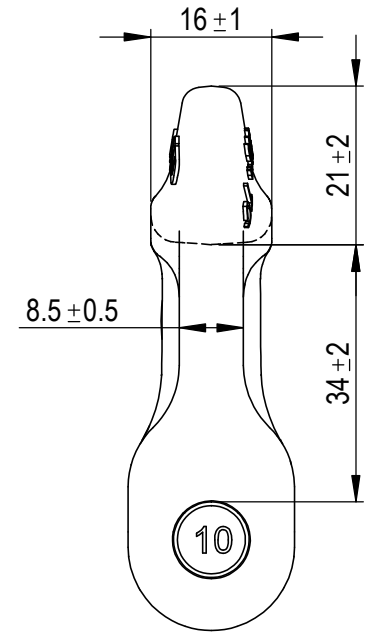
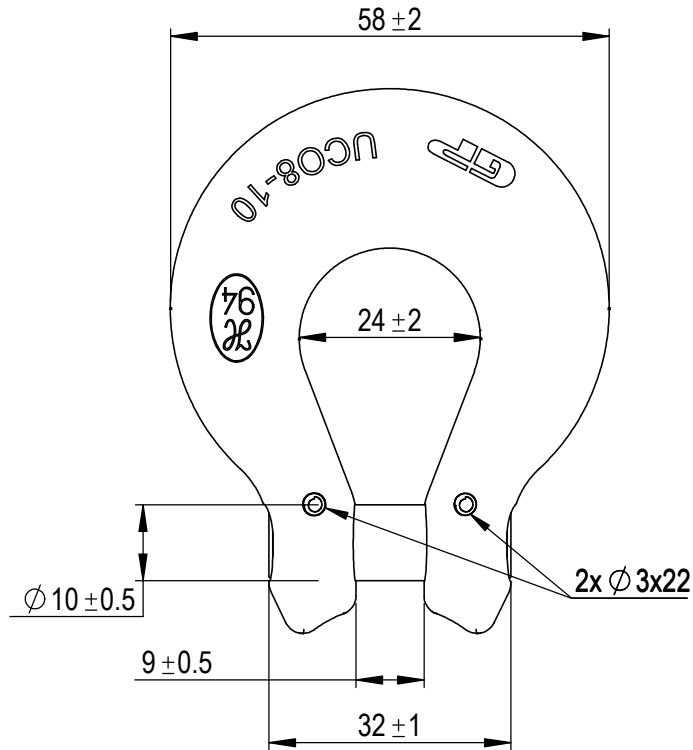
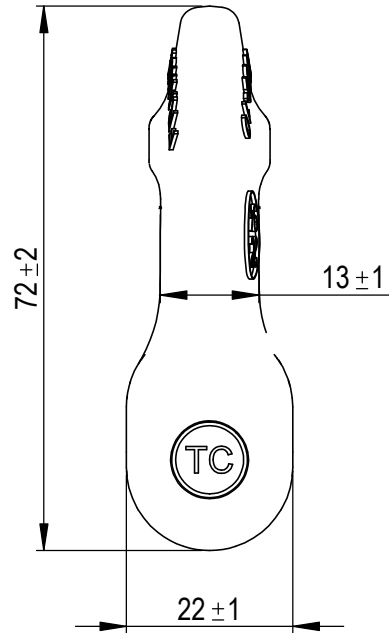
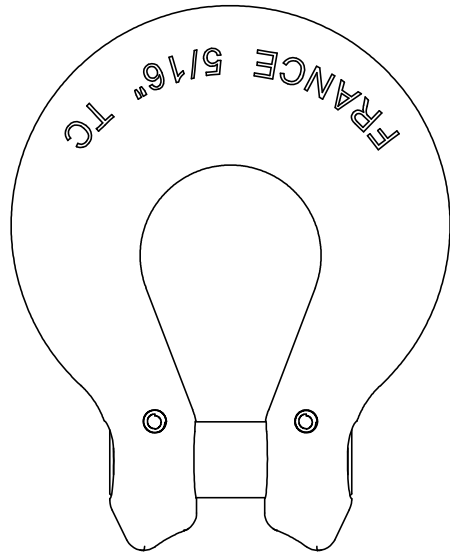

0	First Issue	2018-12-7	R.CH
Rev.	Description	Date	Drawn

Copyright by Van Beest B.V. moreover this document is the property of Van Beest B.V. This document or any part of it may neither be made known, copied or multiplied, nor used for any purpose other than that for which it is specifically furnished, without the prior written consent of Van Beest B.V.

Title **Green Pin® Omega link GR10**

Remark
 UCO
 GPUCO8



P.O. Box 57, 3360 AB Sliedrecht (The Netherlands)
 Industrieweg 6, 3361 HJ Sliedrecht
 Tel. +31(0)184-413300 www.greenpin.com

Format	A4	
Scale	1:1	
Drawing number	7316	Rev.
		0

We reserve the right to make amendments on specifications in this drawing without prior notification.