

Green Pin® Master Link Assembly GR10

Group : UMTS

Part : GPUMTS22

WLL : 6.8t

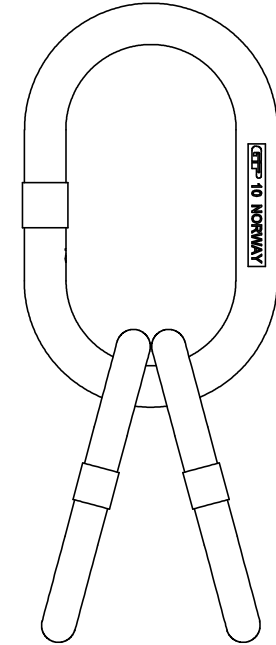
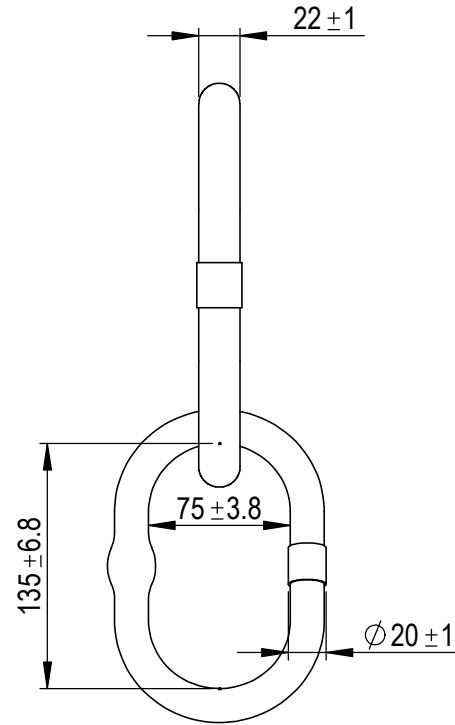
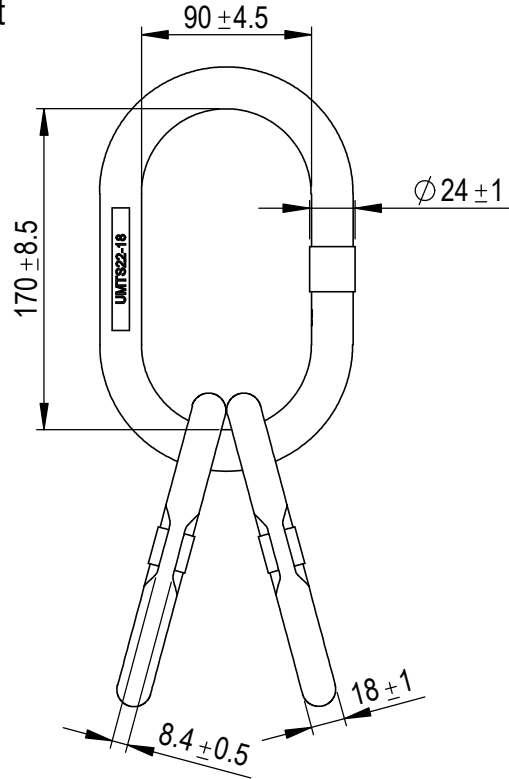

Rev.	Description	Date	Drawn
A	Modify the marking	2021-4-30	R.CH
0	First Issue	2015-3-1	R.CH

Copyright by Van Beest B.V. moreover this document is the property of Van Beest B.V. This document or any part of it may neither be made known, copied or multiplied, nor used for any purpose other than that for which it is specifically furnished, without the prior written consent of Van Beest B.V.

Title Green Pin® Master Link Assembly GR10

Remark
UMTS
GPUMTS22



P.O. Box 57, 3360 AB Sliedrecht
(The Netherlands)
Industrieweg 6, 3361 HJ Sliedrecht
Tel. +31(0)184-413300 www.vanbeest.nl

Format A4
Scale 1:4

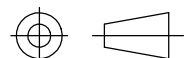

Drawing number 5771
Rev. A

We reserve the right to make amendments on specifications in this drawing without prior notification.