

Green pin® Spring Release ROV Shackle

Group : P-5637

Part : POGHMB75ROVSRL

WLL : 85 t

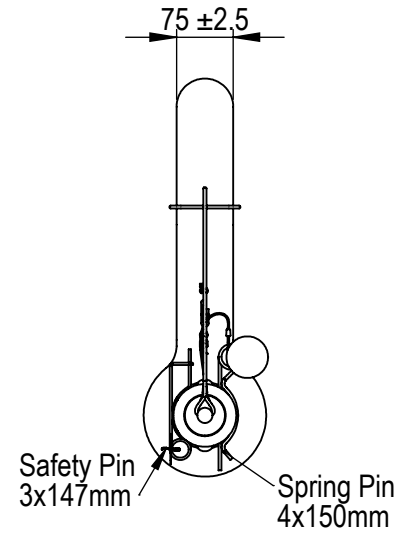
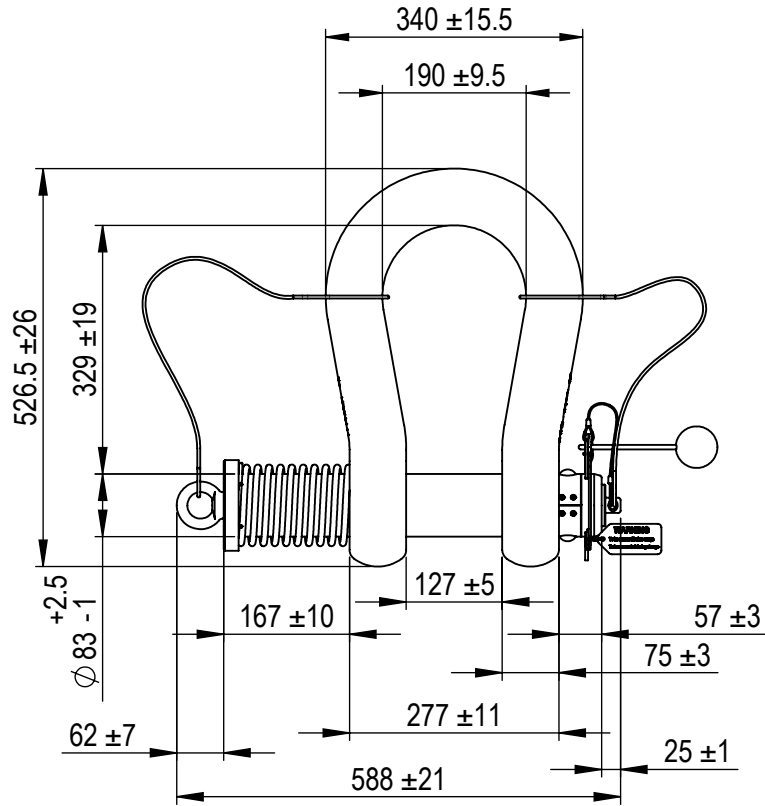
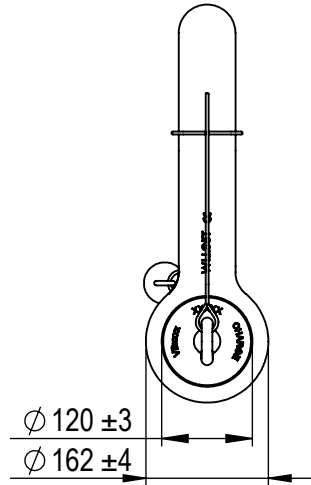

Rev.	Description	Date	Drawn
B	Model Update	01-05-2019	RB
A	Spring release pin design change	01-06-2015	DVDP
0	First Issue	21-02-2014	AH

Copyright by Van Beest B.V. moreover this document is the property of Van Beest B.V. This document or any part of it may neither be made known, copied or multiplied, nor used for any purpose other than that for which it is specifically furnished, without the prior written consent of Van Beest B.V.

Title **Green pin® Spring Release ROV Shackle**

Remark
P-5637
POGHMB75ROVSRL

Green Pin®
P.O. Box 57, 3360 AB Sliedrecht (The Netherlands)
Industrieweg 6, 3361 HJ Sliedrecht
Tel. +31(0)184-413300 www.greenpin.com

Format	A4		
Scale	1:10		
Drawing number	6808	Rev.	B

We reserve the right to make amendments on specifications in this drawing without prior notification.