

Green Pin® Closed Spelter Socket  
 Group : G-6411  
 Part : SKGCS028  
 MBL : 90t

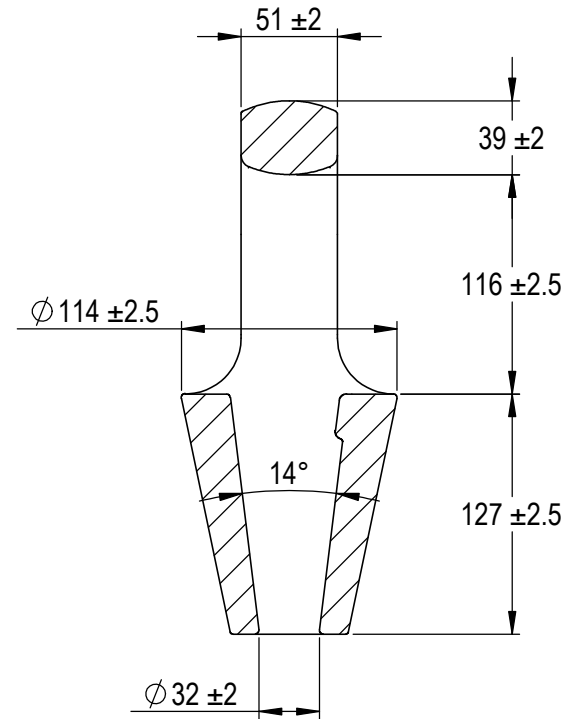
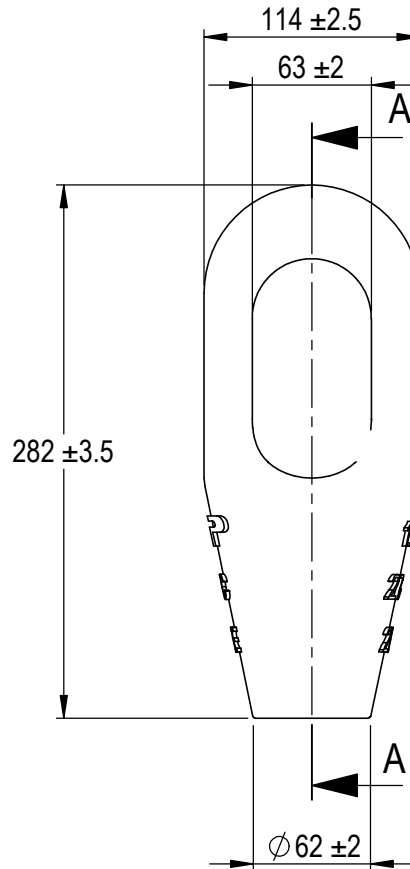
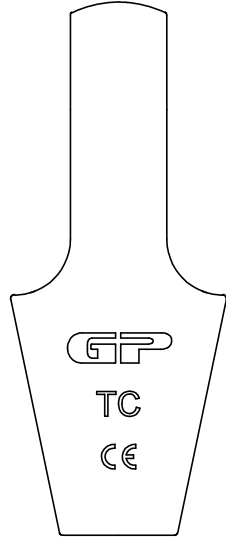
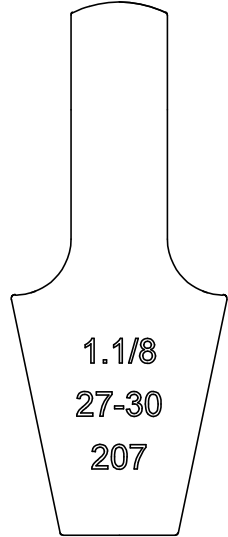

SECTION A-A

Rev.	Description	Date	Drawn
A	New layout markings	2020-11-1	D.L.
0	First Issue	2014-4-1	T.J.

Copyright by Van Beest B.V. moreover this document is the property of Van Beest B.V. This document or any part of it may neither be made known, copied or multiplied, nor used for any purpose other than that for which it is specifically furnished, without the prior written consent of Van Beest B.V.

Title **Green Pin® Closed Spelter Socket**

Remark  
 G-6411  
 SKGCS028



P.O. Box 57, 3360 AB Sliedrecht (The Netherlands)  
 Industrieweg 6, 3361 HJ Sliedrecht  
 Tel. +31(0)184-413300 www.greenpin.com

Format **A4**  
 Scale **1:4**

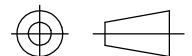

Drawing number **6307** Rev. **A**

We reserve the right to make amendments on specifications in this drawing without prior notification.