

Green Pin® open spelter socket CP
 Group : G-6412
 Part : SKGOS016
 MBL : 25t

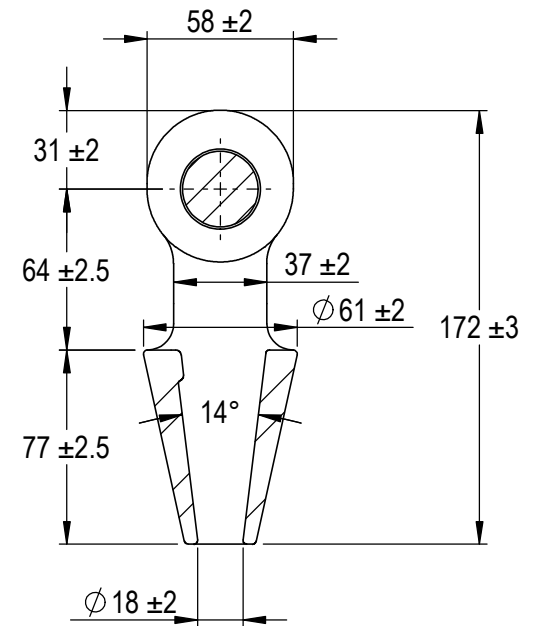
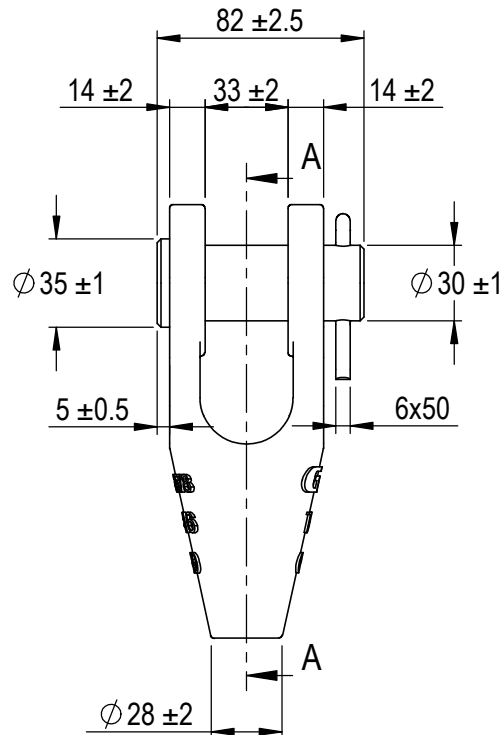
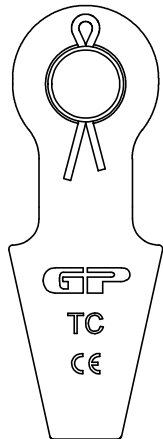

SECTION A-A

Rev.	Description	Date	Drawn
A	New layout markings	2020-11-1	D.L
0	First Issue	2014-4-1	T.J.

Copyright by Van Beest B.V. moreover this document is the property of Van Beest B.V. This document or any part of it may neither be made known, copied or multiplied, nor used for any purpose other than that for which it is specifically furnished, without the prior written consent of Van Beest B.V.

Title **Green Pin® open spelter socket CP**
Open spelter socket with cotter pin

Remark
 G-6412
 SKGOS016



P.O. Box 57, 3360 AB Sliedrecht (The Netherlands)
 Industrieweg 6, 3361 HJ Sliedrecht
 Tel. +31(0)184-413300 www.greenpin.com

Format	A4	
Scale	1:3	
Drawing number	6353	Rev. A

We reserve the right to make amendments on specifications in this drawing without prior notification.