

Green Pin® Open Wedge Socket CP  
 Group : G-6413  
 Part : SKGOW035  
 MBL : 125t

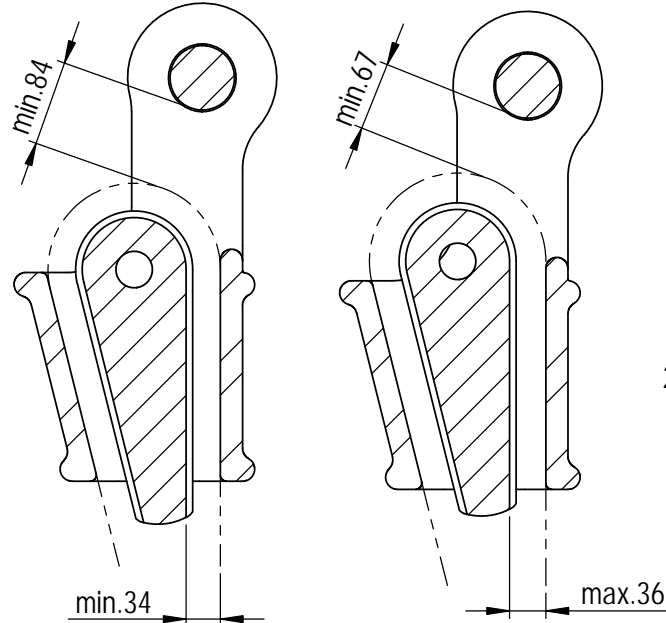

SECTION A-A

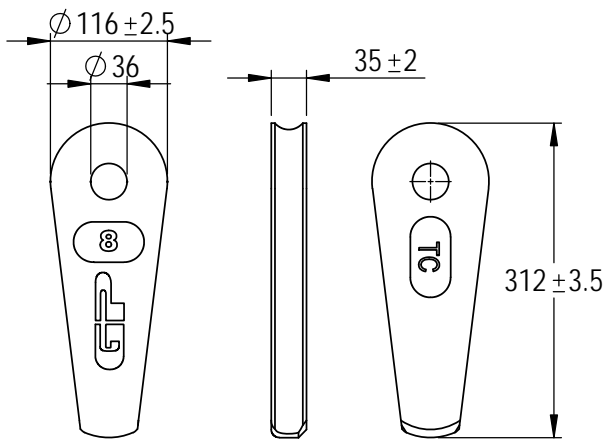
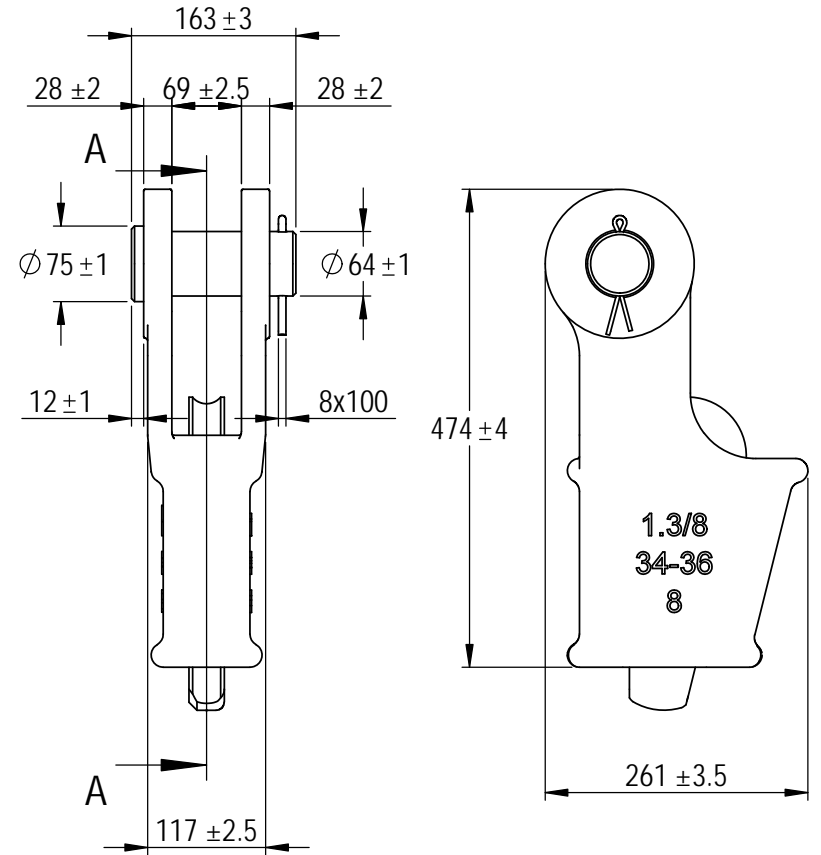
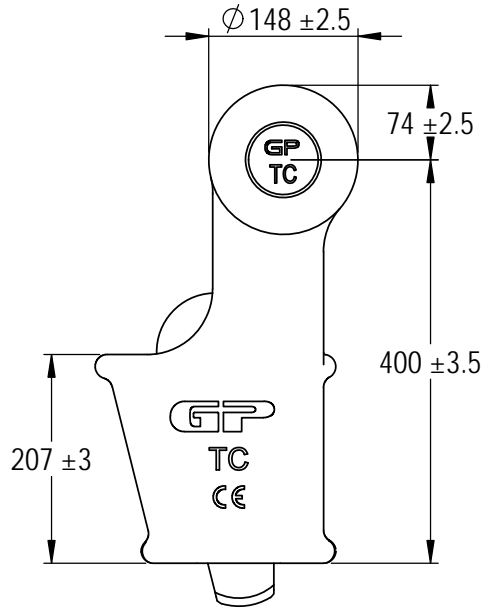

Rev.	Description	Date	Drawn
A	New layout markings	2020-11-1	D.L.
0	First Issue	2014-4-1	R.CH

Copyright by Van Beest B.V. moreover this document is the property of Van Beest B.V. This document or any part of it may neither be made known, copied or multiplied, nor used for any purpose other than that for which it is specifically furnished, without the prior written consent of Van Beest B.V.

Title **Green Pin® Open Wedge Socket CP**  
**Open wedge socket with cotter pin**

Remark  
 G-6413  
 SKGOW035



P.O. Box 57, 3360 AB Sliedrecht (The Netherlands)  
 Industrieweg 6, 3361 HJ Sliedrecht  
 Tel. +31(0)184-413300 www.greenpin.com

Format **A4**  
 Scale **1:7.5**

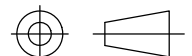

Drawing number **6409** Rev. **A**

We reserve the right to make amendments on specifications in this drawing without prior notification.