

Green Pin® Sling Shackle

Group : P-6033

Part : SLGPF0700

WLL : 700t

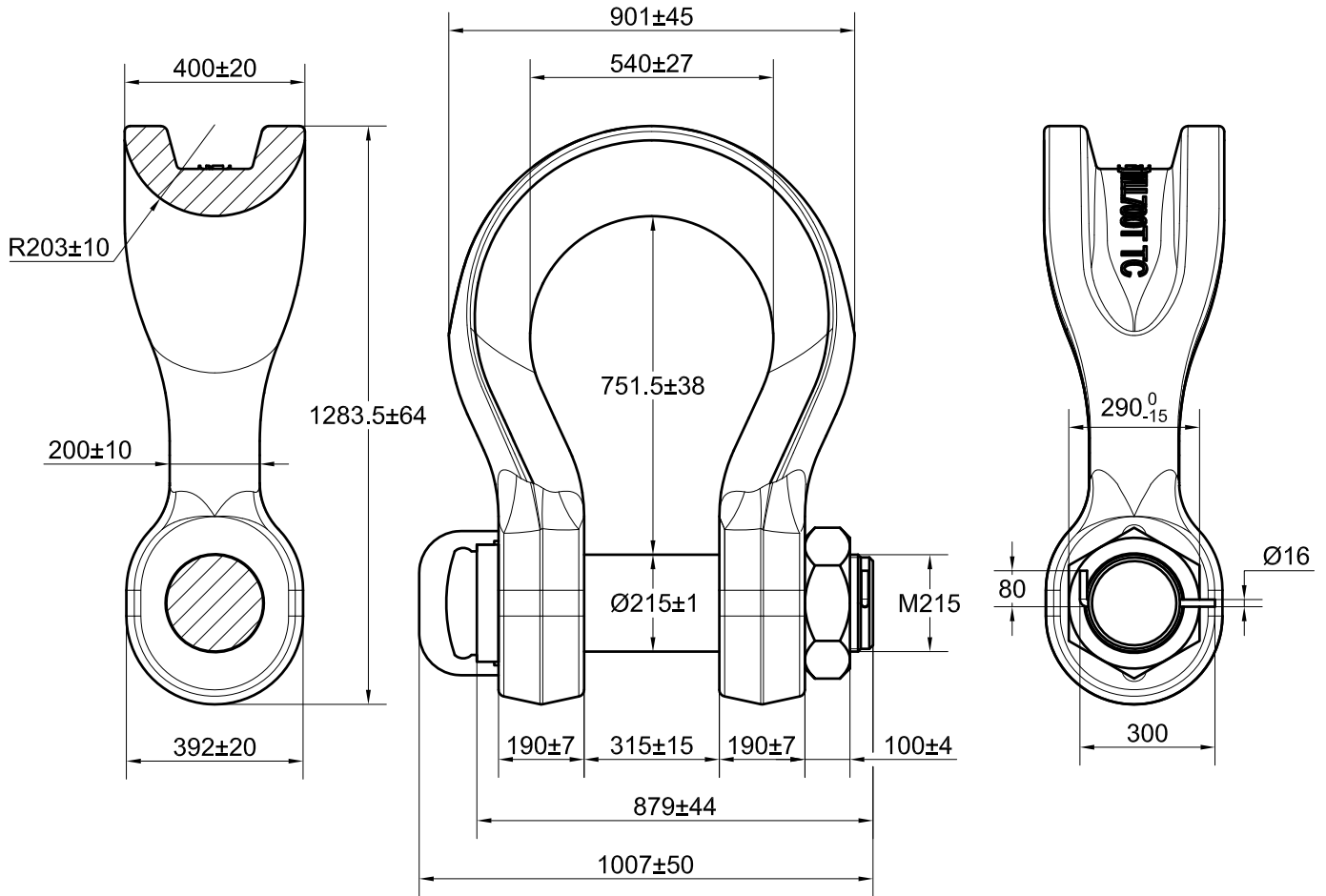
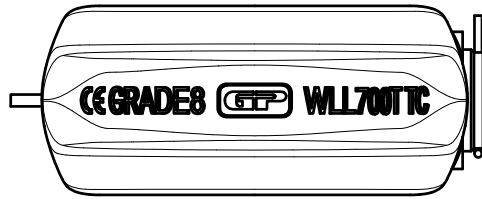

We reserve the right to make amendments on specifications in this drawing without prior notification.

Rev.	Description	Date	Drawn
0	First Issue	2010-9-6	D.L.

Copyright by Van Beest B.V. moreover this document is the property of Van Beest B.V. This document or any part of it may neither be made known, copied or multiplied, nor used for any purpose other than that for which it is specifically furnished, without the prior written consent of Van Beest B.V.

Title	Green Pin® Sling Shackle bow shackle with safety bolt	Remark	P-6033 SLGPF0700
--------------	---	---------------	---------------------



P.O. Box 57, 3360 AB Sliedrecht
(The Netherlands)
Industrieweg 6, 3361 HJ Sliedrecht
Tel. 0184-413300 Fax. 0184-413101

Format	A4	
Scale	1:16	
Drawing number	5287	Rev.
		O

A

B

C

D