

Green Pin® turnbuckles Jaw-Jaw with safety bolt

Group : G-6323

Part : SSGPMBGG2212

WLL : 3.27t

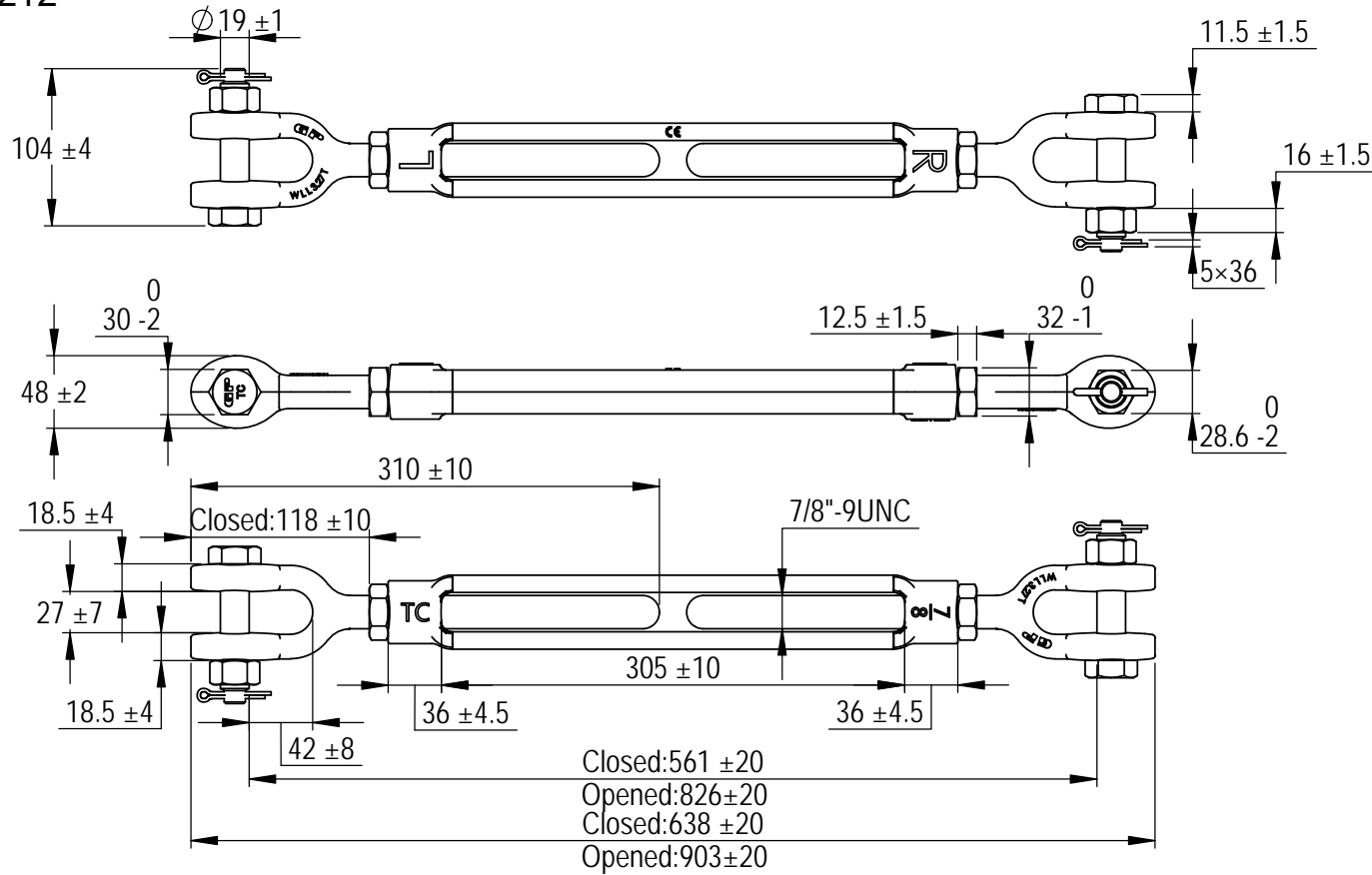

0	First Issue	2014-6-1	T.J.
Rev.	Description	Date	Drawn
Copyright by Van Beest B.V. moreover this document is the property of Van Beest B.V. This document or any part of it may neither be made known, copied or multiplied, nor used for any purpose other than that for which it is specifically furnished, without the prior written consent of Van Beest B.V.			
Title Green Pin® turnbuckles Jaw-Jaw with safety bolt generally to ASTM F1145-92		Remark G-6323 SSGPMBGG2212	

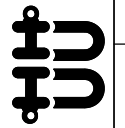
**VAN BEEST** 

P.O. Box 57, 3360 AB Sliedrecht  
(The Netherlands)  
Industrieweg 6, 3361 HJ Sliedrecht  
Tel. +31(0)184-413300 www.vanbeest.nl

Format	A4
Scale	1:5
Drawing number	5561
Rev.	0

We reserve the right to make amendments on specifications in this drawing without prior notification.