

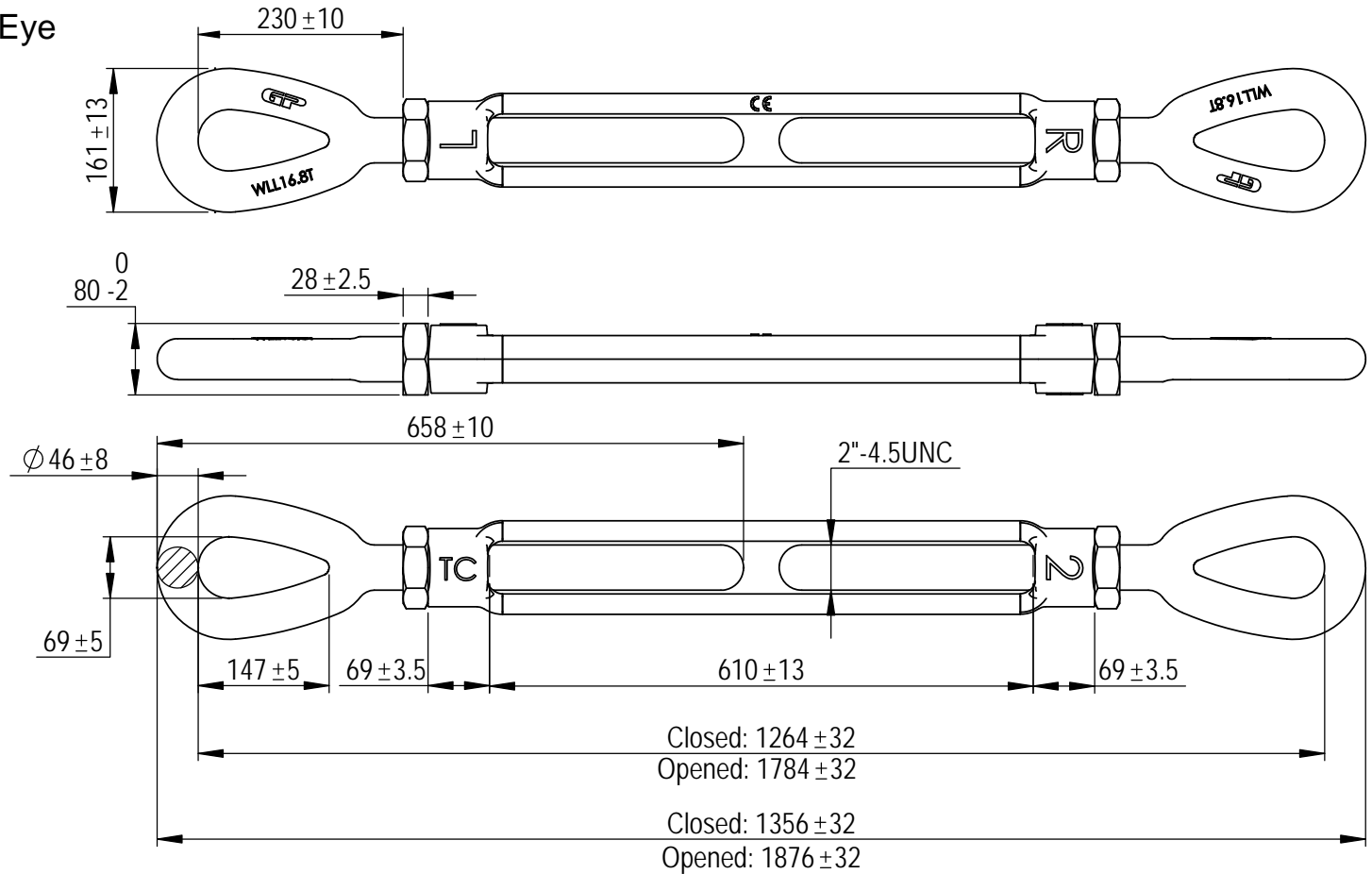

Green Pin® turnbuckles Eye-Eye
 Group : G-6311
 Part : SSGPOO5024
 WLL : 16.8t



0	First Issue	2013-10-1	R.CH
Rev.	Description	Date	Drawn
Copyright by Van Beest B.V. moreover this document is the property of Van Beest B.V. This document or any part of it may neither be made known, copied or multiplied, nor used for any purpose other than that for which it is specifically furnished, without the prior written consent of Van Beest B.V.			
Title Green Pin® turnbuckles Eye-Eye generally to ASTM F1145-92		Remark G-6311 SSGPOO5024	

VAN BEEST 

P.O. Box 57, 3360 AB Sliedrecht
 (The Netherlands)
 Industrieweg 6, 3361 HJ Sliedrecht
 Tel. +31(0)184-413300 www.vanbeest.nl

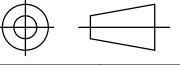
Format	A4	
Scale	1:8	
Drawing number	5375	Rev. 0

We reserve the right to make amendments on specifications in this drawing without prior notification.