

Green Pin® JE Swivel CP
 Group : G-7723
 Part : WTGPGO19
 WLL : 3.3t

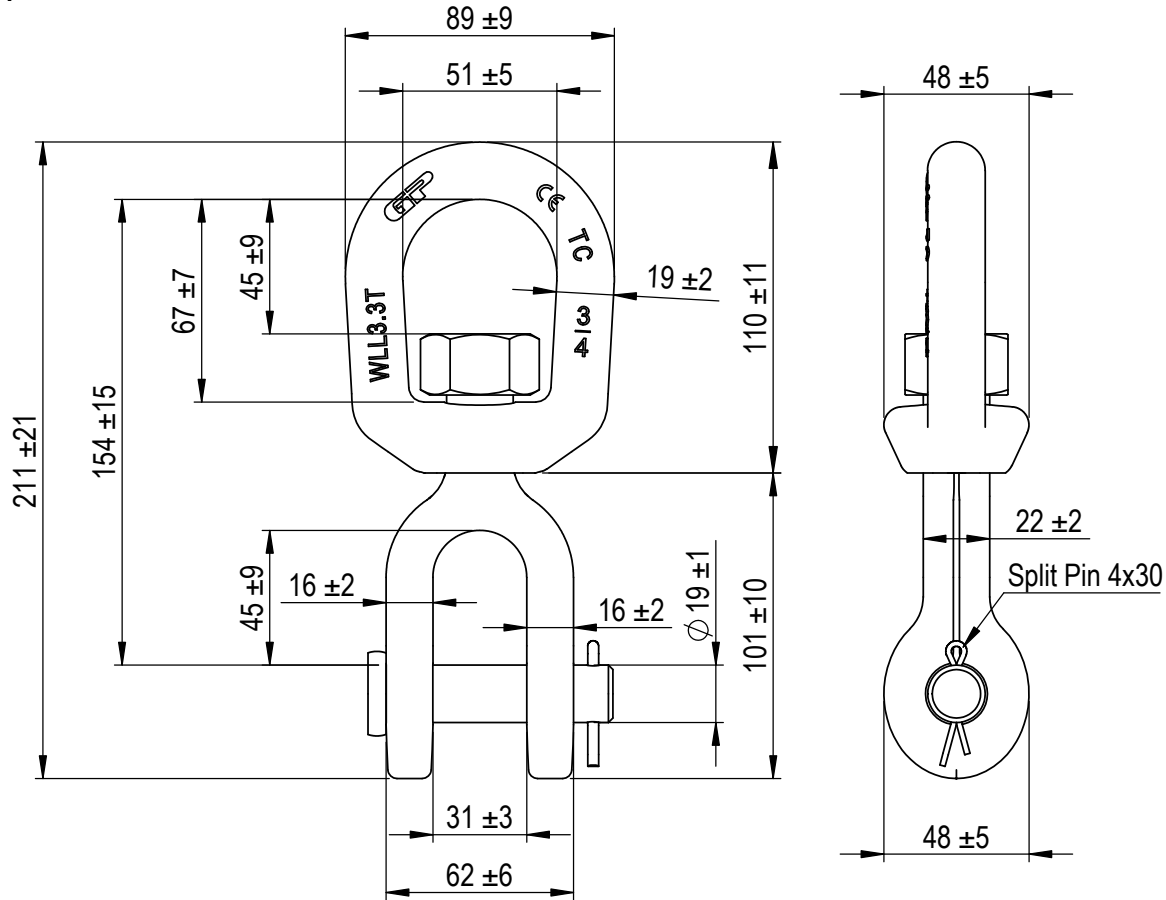

Rev.	Description	Date	Drawn
A	drawing updated	2023/2/15	DL
0	First Issue	2022/1/1	DL

Copyright by Van Beest B.V. moreover this document is the property of Van Beest B.V. This document or any part of it may neither be made known, copied or multiplied, nor used for any purpose other than that for which it is specifically furnished, without the prior written consent of Van Beest B.V.

Title **Green Pin® JE Swivel CP**
 Swivel with jaw-eye end-fitting and cotter pin

Remark
 G-7723
 WTGPGO19



P.O. Box 57, 3360 AB Sliedrecht (The Netherlands)
 Industrieweg 6, 3361 HJ Sliedrecht
 Tel. +31(0)184-413300 www.greenpin.com

Format	A4	
Scale	1:2.5	
Drawing number	5855	Rev. A

We reserve the right to make amendments on specifications in this drawing without prior notification.