

Green Pin® EE Swivel
 Group : G-7713
 Part : WTGPOO32
 WLL : 8.2t

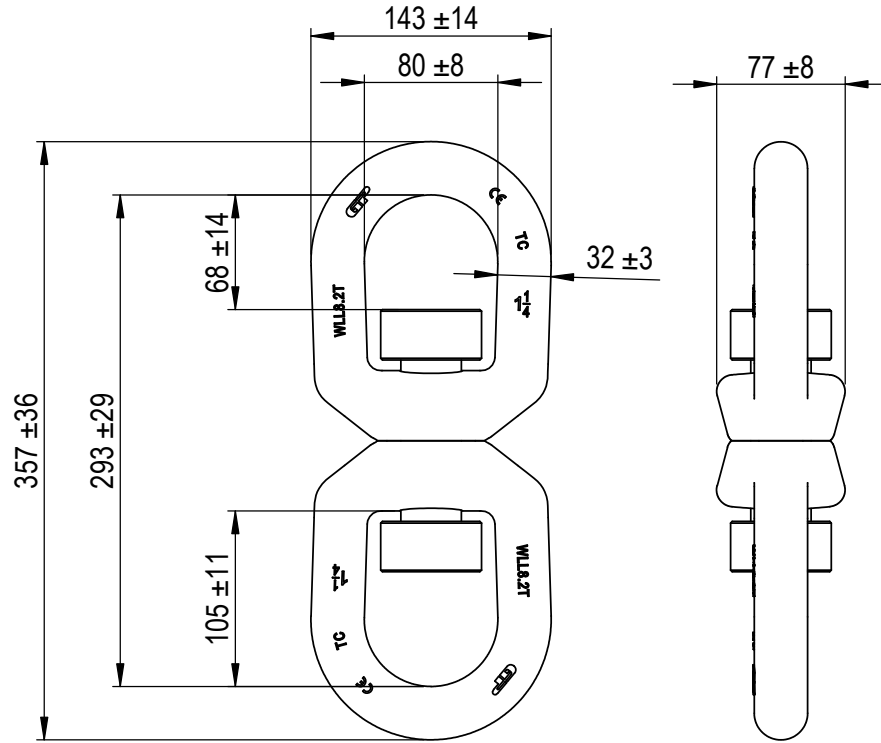

Rev.	Description	Date	Drawn
A	drawing updated	2023/2/15	DL
0	First Issue	2022/1/1	DL

Copyright by Van Beest B.V. moreover this document is the property of Van Beest B.V. This document or any part of it may neither be made known, copied or multiplied, nor used for any purpose other than that for which it is specifically furnished, without the prior written consent of Van Beest B.V.

Title **Green Pin® EE Swivel**
Swivel with eye-eye end-fittings

Remark
 G-7713
 WTGPOO32



Green Pin®
 P.O. Box 57, 3360 AB Sliedrecht (The Netherlands)
 Industrieweg 6, 3361 HJ Sliedrecht
 Tel. +31(0)184-413300 www.greenpin.com

Format	A4	
Scale	1:4.5	
Drawing number	5808	Rev. A

We reserve the right to make amendments on specifications in this drawing without prior notification.